

Overview of the global win-win future!



GTB 港博



GTB 港博



Add: #266 Lingshi Rd, Chengxi Industrial Estate,

Yongkang City, Zhejiang, China 321300

Tel: 0086-57987250582 0086-57987250580

Fax: 0086-57987250581

E-mail: sales@ykgangbo.com

Website: www.cookware-handles.com www.gang-bo.com

ZHEJIANG GANGBO INDUSTRY & TRADE CO.,LTD

2022



Company Profile

浙江港博工贸有限公司，成立于2006年，位于五金之乡浙江永康，是一家专业生产锅类配件的工厂，产品覆盖不锈钢系列、胶木系列、复底片三大类。我们拥有400员工，占地15000平方，月产量400万件。经过多年的发展，我们拥有强大的生产能力，优秀的研发团队，成熟的OEM经验，有竞争力的价格，严格的品质团队和专业的销售团队。我们致力于锅类配件的生产，如不锈钢、胶木、硅胶等手柄、顶珠、侧耳，有着成熟的生产工艺和先进的生产设备。公司产品畅销海内外，受到海内外客人的一致认可与好评，与客人建立了长期友好合作关系。

我们坚信：诚信第一 品质至上 真诚服务 合作双赢的理念，并将持续创新，提供更好的产品与服务。

Zhejiang Gangbo Industry & Trade Co.,Ltd was established in 2006 , located in capital of hardware in China – Yongkang , Zhejiang , which is a professional manufacturer main in producing cookware fittings. Our products covers stainless steel series, bakelite series and induction. At present, 400 experienced workers work in our 15,000 square-meter working area, and monthly output is 4,000,000pcs.

With many years development , we have large production capacity, excellent R& D team, mature OEM experience , competitive price, strictly quality team & professional sales team. We make devotion to the production of the cookware fittings, including long handles , knobs , side handles with different materials stainless steel ,bakelite and silicon, also inductions ect. We have mature workcraft and advanced production equipment. The products are sold well both in domestic market and international market, wins good reputation from customer, and keep long & friendly relationship with customers.

We trust : honest business , quality priority ,sincere service , win-to-win cooperation, continuously innovation.

We will offer better product and service in future.

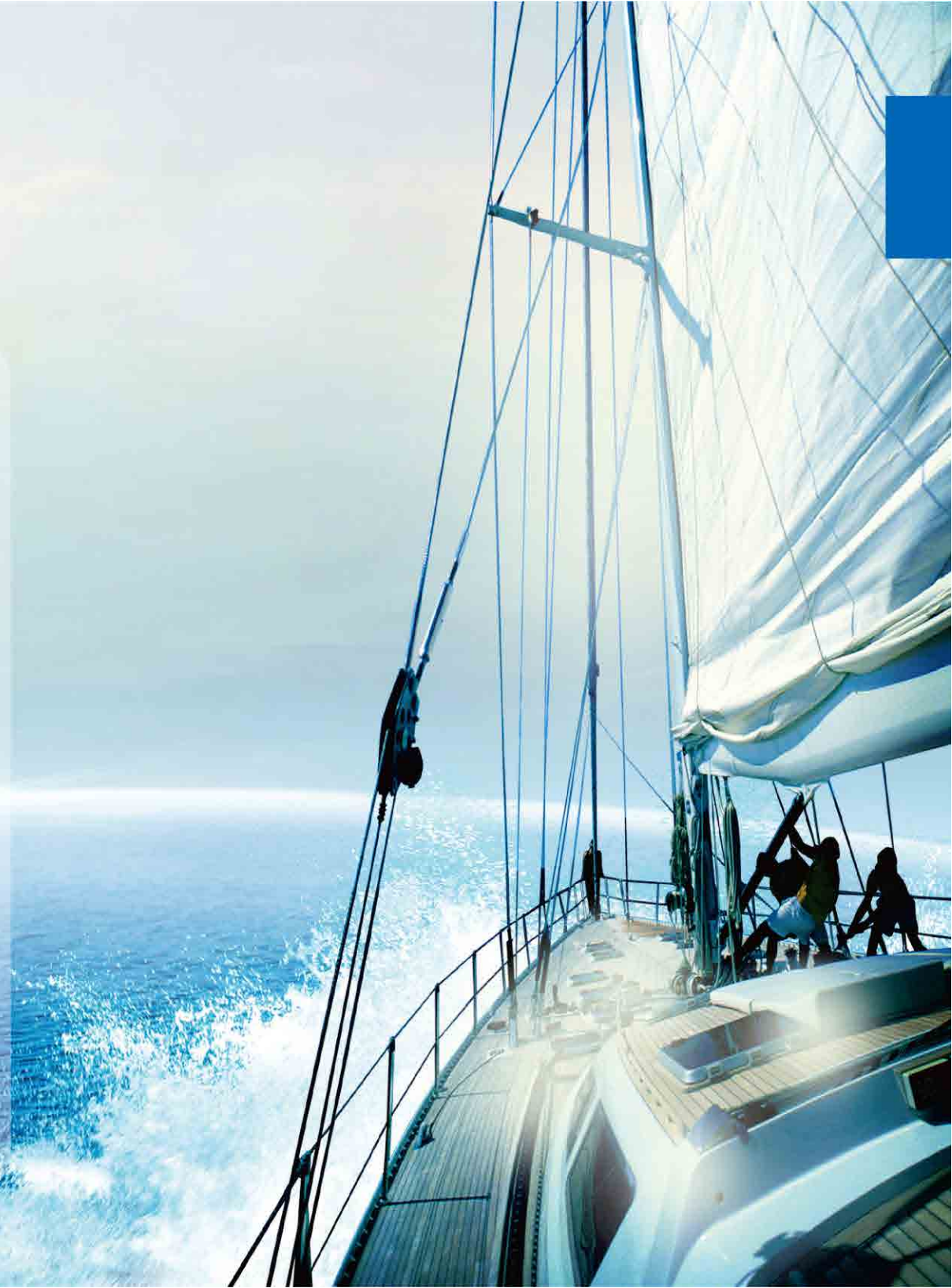



Mod:A003	L.W: 50x13mm
Stainless steel 不锈钢	W.T: 23.3g



Mod:A005	L.W: 21x19mm
Stainless steel 不锈钢	W.T: 23g



Mod:A007	L.W: 33x41mm
Stainless steel 不锈钢	W.T: 53.9g



Mod:A020	L.W: mm
Stainless steel 不锈钢	W.T:



Mod:A021	L.W: 37x50mm
Stainless steel 不锈钢	W.T: 14.4g



Mod:A021-2	L.W: 24x44mm
Stainless steel 不锈钢	W.T: 14.6g



Mod:A008	L.W: 40x60mm
Stainless steel 不锈钢	W.T: 73.3g



Mod:A009	L.W: 41x60mm
Stainless steel 不锈钢	W.T: 74g



Mod:A009-2	L.W: 41x60mm
Stainless steel +Silicone 不锈钢+硅胶	W.T: 76g



Mod:A022	L.W:
Stainless steel 不锈钢	W.T:



Mod:A022-2	L.W:
Stainless steel 不锈钢	W.T:



Mod:A023	L.W: 25x53mm
Stainless steel 不锈钢	W.T: 24.5g



Mod:A011	L.W: 25x90mm
Stainless steel 不锈钢	W.T: 68g



Mod:A011-2	L.W: 30x90mm
Stainless steel 不锈钢	W.T: 72.5g

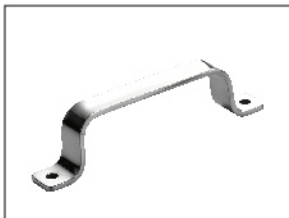

Mod:A013	L.W: 136x14mm
Stainless steel 不锈钢	W.T: 53.9g



Mod:A024	L.W:
Stainless steel 不锈钢	W.T: 16.5g



Mod:A025	L.W: 25x37mm
Stainless steel 不锈钢	W.T: 74g



Mod:A025-2	L.W: 19x19mm
Stainless steel 不锈钢	W.T: 17.1g



Mod:A014	L.W: mm
Stainless steel 不锈钢	W.T: g



Mod:A015	L.W: 120x13mm
Stainless steel 不锈钢	W.T: 68.9g



Mod:A017	L.W: 20x55mm
Stainless steel 不锈钢	W.T: 15.1g



Mod:A025-3	L.W: 28x53mm
Stainless steel 不锈钢	W.T: 16.9g



Mod:A026	L.W: 38x32mm
Stainless steel 不锈钢	W.T: 13.6g



Mod:A029	L.W:
Stainless steel 不锈钢	W.T:



Mod:A031	L.W: 29x49mm
Stainless steel 不锈钢	W.T:



Mod:A032	L.W: 38.5x50mm
Stainless steel 不锈钢	W.T: 23.1g

NEW



Mod:A037	L.W:
Stainless steel 不锈钢	W.T:



Mod:A087	L.W: 36x10mm
Stainless iron 不锈钢	W.T: 21.2g



Mod:A087-2	L.W: 41x6mm
	W.T: 27.8g

NEW



Mod:A088	L.W: 14x145mm
Stainless steel 不锈钢	W.T: 70.2g

NEW



Mod:A039	L.W:
Stainless steel 不锈钢	W.T:



Mod:A041	L.W:
Stainless steel + Bakelite 不锈钢+胶木	W.T:

NEW



Mod:A045	L.W: mm
Stainless steel 不锈钢	W.T: g



Mod:A097	L.W: 11x120mm
Stainless steel 不锈钢	W.T: 65.8g



Mod:A097-2	L.W: 11x120mm
Stainless steel 不锈钢	W.T:



Mod:A099	L.W:
Stainless steel 不锈钢	W.T:

NEW



Mod:A047	L.W: mm
Stainless steel 不锈钢	W.T: g

NEW



Mod:A048	L.W: mm
Stainless iron 不锈钢	W.T: g



Mod:A060-2	L.W:
Stainless iron 不锈钢	W.T:



Mod:A100	L.W: 15x142mm
Stainless steel 不锈钢	W.T: 28.4g



Mod:A103	L.W:
Stainless steel + Silicone 不锈钢+硅胶	W.T:



Mod:A120-3	L.W: 23x65mm
Stainless steel 不锈钢	W.T: 27g



Mod:A074-2	L.W: 170x82mm
Stainless steel 不锈钢	W.T: 74.6g



Mod:A076	L.W: 180x47mm
Stainless iron 不锈钢	W.T: 83.5g



Mod:A084	L.W: 20x130mm
Stainless steel 不锈钢	W.T: 49.7g



Mod:A121	L.W: 35x55mm
Stainless steel 不锈钢	W.T: 29.4g



Mod:A122	L.W: 29x44mm
Stainless steel 不锈钢	W.T:



Mod:A123	L.W:
Stainless steel 不锈钢	W.T:





Mod:A147	L.W: 14x132mm
Stainless steel 不锈钢	W.T: 41.3g



Mod:A150	L.W: 31x51.5mm
Stainless steel 不锈钢	W.T: 25.1g



Mod:A150-2	L.W: 31x51.5mm
Stainless steel 不锈钢	W.T: 25.1g



Mod:A180	L.W: 23x50mm
Stainless steel 不锈钢	W.T: 23.8g



Mod:A181	L.W:
Stainless steel 不锈钢	W.T:



Mod:A182	L.W: 33x52mm
Stainless steel 不锈钢	W.T: 27.4g



Mod:A152	L.W: 110x18mm
Stainless steel 不锈钢	W.T: 72.6g



Mod:A153	L.W:
Stainless steel 不锈钢	W.T:



Mod:A154	L.W: 12x123mm
Stainless steel 不锈钢	W.T: 71.1g



Mod:A183	L.W: 20x35mm
Stainless iron 不锈钢	W.T: 71.7g



Mod:A184	L.W: 55x80mm
Stainless iron 不锈钢	W.T: 76.3g



Mod:A185	L.W: 55x80mm
Stainless steel 不锈钢	W.T: 64.5g



Mod:A155	L.W: 14x120mm
Stainless steel 不锈钢	W.T: 53.6g



Mod:A157	L.W:
Stainless steel 不锈钢	W.T:



Mod:A160	L.W:
Stainless steel 不锈钢	W.T:



Mod:A196	L.W: 31.5x134.5mm
Stainless steel 不锈钢	W.T: 111.6g



Mod:A198	L.W: 29.5x124mm
Stainless steel 不锈钢	W.T: 32g



Mod:A199	L.W: 28x44.5mm
Stainless steel 不锈钢	W.T: 25.5g



Mod:A165	L.W: 26.5x55mm
Stainless steel 不锈钢	W.T: 25.4g



Mod:A169	L.W: 17x115mm
Stainless steel 不锈钢	W.T: 74.4g



Mod:A174	L.W:
Stainless steel 不锈钢	W.T:

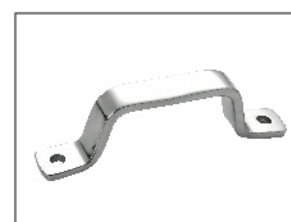

Mod:A200	L.W: 39x127.5mm
Stainless steel 不锈钢	W.T: 111.7g



Mod:A203	L.W:
Stainless steel 不锈钢	W.T:



Mod:A212	L.W: 11x110mm
Stainless steel 不锈钢	W.T:



Mod:A213	L.W: 29x103.5mm
Stainless steel 不锈钢	W.T:



Mod:A214	L.W: 29x103.5mm
Stainless steel 不锈钢	W.T: 20.6g

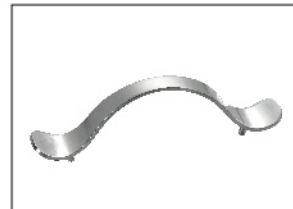

Mod:A216	L.W: 38.5x166mm
Stainless steel 不锈钢	W.T: 81.1g



Mod:B010-2	L.W: 55x84mm
Stainless steel 不锈钢	W.T: 76.4g



Mod:B011	L.W: 26.5x75mm
Stainless steel 不锈钢	W.T: 92g



Mod:B017	L.W: mm
Stainless steel 不锈钢	W.T: g



Mod:A216-2	L.W: 44x210mm
Stainless steel 不锈钢	W.T: 143g



Mod:A217	L.W: 25x40mm
Stainless steel 不锈钢	W.T: 73.1g



Mod:A220大	L.W: 36.5x100mm
Stainless steel 不锈钢	W.T: 72.4g



Mod:B025	L.W: 55x92mm
Stainless steel 不锈钢	W.T: 121.1g



Mod:B025-2	L.W: 55x92mm
Stainless steel 不锈钢	W.T: 67.1g

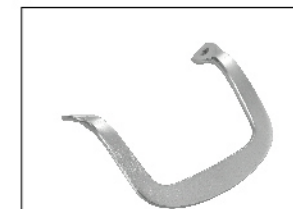

Mod:B025-3	L.W: 55x88mm
Stainless steel 不锈钢	W.T: 94.7g



Mod:B004	L.W:
Stainless steel 不锈钢	W.T: 46g



Mod:B005	L.W: 42x92mm
Stainless steel 不锈钢	W.T: 57g

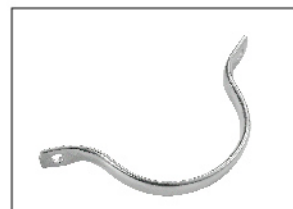

Mod:B006	L.W: 41x83mm
Stainless steel 不锈钢	W.T: 67.4g



Mod:B026	L.W: 60x92mm
Stainless steel 不锈钢	W.T: 84.8g



Mod:B026-2	L.W:
Stainless steel 不锈钢	W.T:



Mod:B031-2	L.W:
Stainless steel +Silicone 不锈钢+硅胶	W.T:



Mod:B008	L.W: 48x78mm
Stainless steel 不锈钢	W.T: 26.1g



Mod:B009	L.W: 55x88mm
Stainless steel 不锈钢	W.T: 26.5g



Mod:B010	L.W: 48x74mm
Stainless steel 不锈钢	W.T: 70.5g



Mod:B032	L.W:
Stainless steel +Silicone 不锈钢+硅胶	W.T:



Mod:B033	L.W:
Stainless steel 不锈钢	W.T:



Mod:B040	L.W: 44x100mm
Stainless steel 不锈钢	W.T: 36.4g



Mod:B041	L.W: 59.5x91mm
Stainless steel 不锈钢	W.T: 15.5g



Mod:B042	L.W: 43x126mm
Stainless steel 不锈钢	W.T: 51.8g



Mod:B043	L.W: 16x130mm
Stainless steel 不锈钢	W.T: 85.9g



Mod:B062	L.W: 47x88mm
Stainless steel 不锈钢	W.T: 94.9g



Mod:B067	L.W: 70x96mm
Stainless steel 不锈钢	W.T: 86.9g



Mod:B069	L.W: 48.5x93.5mm
Stainless steel 不锈钢	W.T: 96.2g



Mod:B044	L.W:
Stainless steel + Silicone 不锈钢+硅胶	W.T:



Mod:B045	L.W: 48.5x130.5mm
Stainless steel 不锈钢	W.T: 47g



Mod:B045-2	L.W: 44.5x136.5mm
Stainless steel + Silicone 不锈钢+硅胶	W.T: 52g

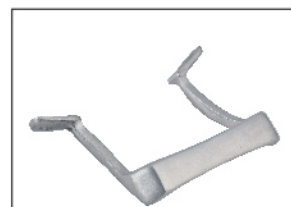

Mod:B072	L.W:
Stainless steel 不锈钢	W.T:



Mod:B075	L.W: 15x90mm
Stainless steel 不锈钢	W.T: 84.3g

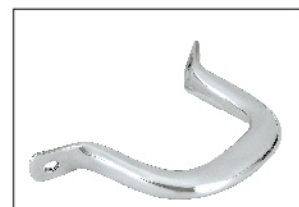

Mod:B076	L.W: mm
Stainless steel 不锈钢	W.T:



Mod:B046	L.W: mm
Stainless steel 不锈钢	W.T:



Mod:B047	L.W: 43.5x87mm
Stainless steel + Silicone 不锈钢+硅胶	W.T: 45g



Mod:B053	L.W:
Stainless steel 不锈钢	W.T:



Mod:B086	L.W:
Stainless steel 不锈钢	W.T:



Mod:B090	L.W:
Stainless steel 不锈钢	W.T:



Mod:B091	L.W: 53x103mm
Stainless steel 不锈钢	W.T: 112g



Mod:B055	L.W: 65x100mm
Stainless steel 不锈钢	W.T: 83.9g



Mod:B057	L.W: 56x89mm
Stainless steel 不锈钢	W.T: 88.7g



Mod:B058	L.W: 47x88mm
Stainless steel 不锈钢	W.T: 47g



Mod:B092	L.W: 73x82mm
Stainless steel 不锈钢	W.T: 123.8g



Mod:B098	L.W:
Stainless steel 不锈钢	W.T:

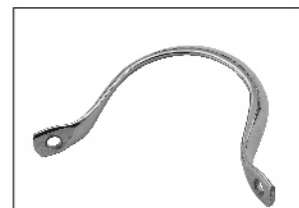

Mod:B099	L.W: 36x58mm
Stainless steel 不锈钢	W.T: 91.9g

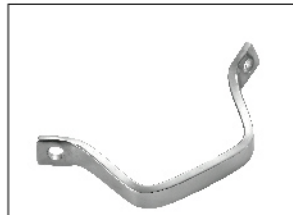

Mod:B101	L.W: 46.5x139.5mm
Stainless steel 不锈钢	W.T: 142g



Mod:B103	L.W: 37x55mm
Stainless steel 不锈钢	W.T: 75g



Mod:B108	L.W: 65.5x110.5mm
Stainless steel 不锈钢	W.T:



Mod:B109	L.W: 54x92mm
Stainless steel 不锈钢	W.T: 58.8g



Mod:B110	L.W:
Stainless steel 不锈钢	W.T:



Mod:B112	L.W:
Stainless steel 不锈钢	W.T:



Mod:B113	L.W: 50x124mm
Stainless steel 不锈钢	W.T: 40.3g



Mod:B114	L.W: 91x51mm
Stainless steel 不锈钢	W.T: 113.1g

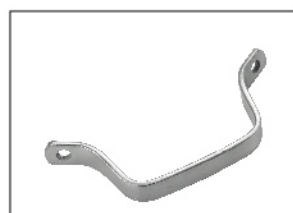

Mod:B115	L.W: 33x88mm
Stainless steel 不锈钢	W.T: 77.9g



Mod:C001	L.W: 170x38mm	W.T: 83.1g
Stainless steel 不锈钢	190x38mm	220x38mm 103.6g



Mod:C001-2	L.W: 170x38mm	W.T: 83.1g
Stainless steel + Silicone 不锈钢+硅胶	190x38mm	220x38mm 103.6g



Mod:C002	L.W: 190x24mm	W.T: 127.9g
Stainless steel 不锈钢	220x24mm	



Mod:C003	L.W: 80x210mm
Stainless steel 不锈钢	W.T: 202g



Mod:C004	L.W: 220x38mm
Stainless steel 不锈钢	W.T: 240g



Mod:C006	L.W: 165x38mm	W.T: 61.4g
Stainless steel 不锈钢	190x38mm	220x38mm 124g



Mod:C006-1	L.W: 165x38mm	W.T: 75g
Stainless steel 不锈钢	190x38mm	220x38mm



Mod:C007	L.W: 180x30mm
Stainless steel 不锈钢	W.T: 93g



Mod:C009	L.W: 160x30mm
Stainless steel + Silicone 不锈钢+硅胶	W.T: 127g



Mod:C011	L.W: 185x30mm	W.T:
Stainless steel + Silicone 不锈钢+硅胶	205x30mm	



Mod:C019	L.W: 30x230mm
Stainless steel 不锈钢	W.T: 163g



Mod:C021	L.W: 170x30mm
Stainless steel 不锈钢	W.T: 132g



Mod:C024-2	L.W:
Stainless steel 不锈钢	W.T:



Mod:C030	L.W:
Stainless steel 不锈钢	W.T:



Mod:C031	L.W:
Stainless steel 不锈钢	W.T:



Mod:C062	L.W:	W.T:
Stainless steel 不锈钢	180x30mm 200x30mm 220x30mm	125.3g 132.3g



Mod:C063	L.W: 80x190mm
Stainless steel + Silicone 不锈钢+硅胶	W.T: 192g



Mod:C064	L.W:	W.T:
Stainless steel 不锈钢	170x28mm 190x28mm 210x28mm	98.4g 125.2g



Mod:C035	L.W:
Iron+spray 铁+喷塑	W.T:



Mod:C036	L.W: 130x23mm
Stainless steel + Silicone 不锈钢+硅胶	W.T: 50.6g



Mod:C038	L.W: 200x31mm
Stainless steel 不锈钢	W.T:



Mod:C064-2	L.W:	W.T:
Stainless steel 不锈钢	170x28mm 190x28mm 210x28mm	100g 113.4g 135.4g



Mod:C070	L.W:
Stainless steel 不锈钢	W.T: 105.2g



Mod:C070-2	L.W:
Stainless steel 不锈钢	W.T: 105.2g



Mod:C038-2	L.W: 200x31mm
Stainless steel + Silicone 不锈钢+硅胶	W.T:



Mod:C054	L.W:	W.T:
Stainless steel 不锈钢	180x25mm 200x25mm 220x25mm	87.2g 105g



Mod:C054-2	L.W:	W.T:
Stainless steel + Silicone 不锈钢+硅胶	180x25mm 200x25mm 220x25mm	113g



Mod:C080	L.W:	W.T:
Stainless steel 不锈钢	170x28mm 190x28mm	145.9g 162.4g



Mod:C083	L.W:30x220mm
Stainless steel 不锈钢	W.T: 124.2g



Mod:C084	L.W: 12x170mm
Stainless steel 不锈钢	W.T: 157.4g



Mod:C054-3	L.W:	W.T:
Stainless steel 不锈钢	180x25mm 200x25mm 220x25mm	89.8g 101.2g



Mod:C059	L.W:	W.T:
Stainless steel 不锈钢	170x28mm 190x28mm 210x28mm	111.2g 112g 136.3g



Mod:C060	L.W:	W.T:
Stainless steel 不锈钢	170x25mm 210x25mm	91.3g 112g



Mod:C085	L.W:	W.T:
Stainless steel 不锈钢	175x70mm 200x70mm 220x70mm	89g 92g 112g



Mod:C086	L.W:	W.T:
Stainless steel 不锈钢	185x62mm 215x62mm	97.7g 128.8g



Mod:C093	L.W:
Stainless steel 不锈钢	W.T:



Mod:C094	L.W: 71x235mm	
Stainless steel 不锈钢	W.T: 151g	

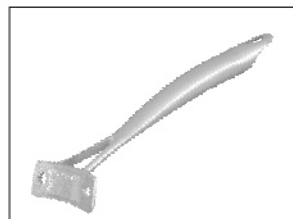

Mod:C097	L.W: 180x28mm	W.T: 148g
Stainless steel 不锈钢	210x28mm	160g



Mod:C098	L.W: 128x18mm	
Stainless steel 不锈钢	W.T: 144.9g	



Mod:C109	L.W: 170x25mm	W.T: 130g
Stainless steel 不锈钢	210x25mm	163g



Mod:C110	L.W:	
Stainless steel 不锈钢	W.T:	



Mod:C114	L.W: 160x21mm	W.T: 109g
Stainless steel 不锈钢	200x25mm	140g
	210x26mm	156g



Mod:C099	L.W: 165x23mm	W.T: 101g
Stainless steel 不锈钢	195x23mm	131g
	215x23mm	133g



Mod:C100	L.W: 190x30mm	W.T: 141g
Stainless steel 不锈钢	230x30mm	159.1g



Mod:C101-1	L.W:	W.T:
Stainless steel 不锈钢		



Mod:C115	L.W: 28x190mm	
Stainless steel 不锈钢	W.T: 167.8g	



Mod:C117	L.W:	
Stainless steel 不锈钢	W.T:	



Mod:C120	L.W: 175x20mm	W.T: 160.9g
Stainless steel 不锈钢	200x20mm	147.5g



Mod:C102	L.W: 170x24mm	W.T: 121g
Stainless steel 不锈钢	190x24mm	131g
	210x24mm	172g



Mod:C103	L.W: 190x73mm	W.T: 123g
Stainless steel 不锈钢	220x73mm	142g



Mod:C104	L.W: 185x65mm	W.T: 124g
Stainless steel 不锈钢	220x65mm	137.3g



Mod:C121	L.W: 175x25mm	
Stainless steel 不锈钢	W.T: 146.6g	



Mod:C122	L.W: 175x30mm	W.T: 120.8g
Stainless steel 不锈钢	200x30mm	140.7g

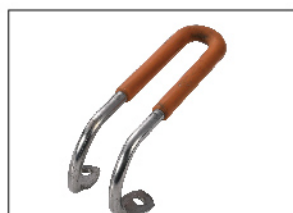

Mod:C123	L.W:	
Stainless steel + Silicone 不锈钢+硅胶	W.T:	



Mod:C105	L.W: 165x30mm	W.T: 120g
Stainless steel 不锈钢	195x30mm	131g
	215x30mm	145g



Mod:C107	L.W: 190x30mm	W.T: 98.6g
Stainless steel 不锈钢	210x30mm	104g
	230x30mm	118g



Mod:C108	L.W: 170x25mm	W.T: 96g
Stainless steel 不锈钢	190x25mm	117g
	210x25mm	137g



Mod:C125	L.W: 160x36mm	
Stainless steel 不锈钢	W.T: 202g	

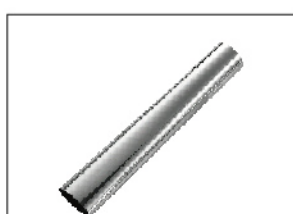

Mod:C129	L.W: 160x36mm	
Stainless steel 不锈钢	W.T: 66.6g	



Mod:C138	L.W: 30x174mm	
Stainless steel 不锈钢	W.T:	



Mod:C159	L.W: 195x24mm	W.T: 99g
Stainless steel 不锈钢	215x27mm 119.9g	



Mod:C160	L.W: 195x26mm	
Stainless steel 不锈钢	W.T: 150.5g	



Mod:C161	L.W: 170x25mm	W.T: 128g
Stainless steel 不锈钢	200x30mm	



Mod:C162	L.W: 200x28mm	
Stainless steel 不锈钢	W.T: 156.6g	



Mod:C163	L.W: 165x28mm	W.T: 145g
Stainless steel 不锈钢	185x28mm 205x28mm	



Mod:C164	L.W: 175x25mm	W.T: 105g
Stainless steel 不锈钢	200x30mm 136g	



Mod:C165	L.W: 165x35mm	
Stainless steel 不锈钢	W.T: 154g	



Mod:C166	L.W: 160x28mm	W.T: 119g
Stainless steel 不锈钢	185x28mm 132g	



Mod:C167	L.W: 180x30mm	W.T: 162g
Stainless steel 不锈钢	205x30mm 225x30mm	



Mod:C139	L.W: 188x30mm	W.T: 149.6g
Stainless steel 不锈钢	205x30mm 157.9g	



Mod:C154	L.W: 165x24mm	W.T: 88.3g
Stainless steel 不锈钢	195x30mm 119g 220x30mm 136.5g	



Mod:C157	L.W: 170x30mm	W.T: 92g
Stainless steel 不锈钢	190x30mm 136.7g 215x30mm 153g	



Mod:C168	L.W: 1	W.T:
Stainless steel 不锈钢		



Mod:DA001	L.W: 47x73mm
Bakelite 胶木	W.T: 33.9g



Mod:DA001-1	L.W: 51x69mm
Bakelite 胶木	W.T: 47.2g



Mod:DA002	L.W: 44x66mm
Bakelite 胶木	W.T: 66.8g



Mod:DB004	L.W:
Bakelite 胶木	W.T:



Mod:DB005	L.W: 80x80mm
Bakelite 胶木	W.T: 136g



Mod:DB006	L.W:
Bakelite 胶木	W.T:



Mod:DA005	L.W: 33x65mm
Bakelite 胶木	W.T: 68g



Mod:DA007	L.W: 20x130mm
Stainless steel +Bakelite 不锈钢+胶木	W.T: 65.5g



Mod:DA008	L.W: 67x70mm
Bakelite 胶木	W.T: 76.4g



Mod:DB007	L.W: 15x130mm
Stainless steel +Bakelite 不锈钢+胶木	W.T: 65.4g



Mod:DB008	L.W: 70x77mm
Bakelite 胶木	W.T: 95g



Mod:DB011	L.W: 66x83mm
Bakelite 胶木	W.T: 55g



Mod:DA014	L.W: 53x53mm
Bakelite 胶木	W.T: 40.6g



Mod:DA016	L.W: 58x88mm
Bakelite 胶木	W.T: 43.3g



NEW

Mod:DA017	L.W:
Bakelite 胶木	W.T:



Mod:DB013	L.W: mm
Bakelite 胶木	W.T: g



Mod:DB014	L.W: mm
Bakelite 胶木	W.T: g



Mod:DB017	L.W: 85x85mm
Stainless steel +Bakelite 不锈钢+胶木	W.T: 115g



NEW

Mod:DA020	L.W:
Stainless steel + Silicone 不锈钢+硅胶	W.T:



Mod:DB002	L.W:
Bakelite 胶木	W.T:



Mod:DB003	L.W:
Stainless steel +Bakelite 不锈钢+胶木	W.T:



Mod:DB018	L.W: 65x97mm
Bakelite 胶木	W.T: 71g



Mod:DC018-1	L.W: 33x68mm
Bakelite 胶木	W.T: 95g



NEW

Mod:DB019	L.W:
Stainless steel +Bakelite 不锈钢+胶木	W.T:



Mod:DB020	L.W:
Stainless steel +Bakelite 不锈钢+胶木	W.T:



Mod:DB021	L.W:
Stainless steel +Bakelite 不锈钢+胶木	W.T:



Mod:DB022	L.W: 65x97mm
Bakelite 胶木	W.T: 71g



Mod:DC019	L.W: 45x175mm
Bakelite 胶木	W.T: 136g



Mod:DC020	L.W:
Bakelite 胶木	W.T:



Mod:DC025	L.W: 40x200mm
Bakelite 胶木	W.T: 101g



Mod:DB023	L.W: 85x85mm
Stainless steel +Bakelite 不锈钢+胶木	W.T: 115g



Mod:DC001	L.W: 45x195mm
Bakelite 胶木	W.T: 186g



Mod:DC002-1	L.W: 40x200mm
Bakelite 胶木	W.T: 230g



Mod:DC026	L.W:
Bakelite 胶木	W.T:



Mod:DC027	L.W: 39x55mm
Bakelite 胶木	W.T: 67g



Mod:DC028	L.W: 45x175mm
Stainless steel +Bakelite 不锈钢+胶木	W.T: 75g



Mod:DC006	L.W: 58x205mm
Stainless steel +Bakelite 不锈钢+胶木	W.T: 136g



Mod:DC007	L.W: 175x60mm	W.T: 133g
Stainless steel +Bakelite 不锈钢+胶木	195x60mm	150g



Mod:DC003	L.W:
Stainless steel +Bakelite 不锈钢+胶木	W.T:



Mod:DC030	L.W: 44x222mm
Bakelite 胶木	W.T: 128g



Mod:DC034	L.W: mm
Bakelite 胶木	W.T: g



Mod:DC037	L.W: mm
Stainless steel +Bakelite 不锈钢+胶木	W.T: g



Mod:DA009	L.W: 20x130mm
Bakelite 胶木	W.T: 65.5g



Mod:DC013	L.W: 41x200mm
Bakelite 胶木	W.T: 148g



Mod:DC015	L.W:
Bakelite 胶木	W.T:



Mod:DC039	L.W: 37x160mm	W.T: 155g
Stainless steel +Bakelite 不锈钢+胶木	40x190mm	208g



Mod:DC041	L.W: 180x55mm	W.T: 144g
Bakelite 胶木	195x35mm	175g



Mod:DC044	L.W: 60x190mm
Stainless steel +Bakelite 不锈钢+胶木	W.T: 151g



Mod:DC045	L.W:
Bakelite 胶木	W.T:



Mod:DC046	L.W: 40x195mm
Bakelite 胶木	W.T: 46g



Mod:DC047	L.W: 33x130mm
Bakelite 胶木	W.T: 114g



Mod:DC052	L.W: mm
Bakelite 胶木	W.T: g



Mod:D002	Stainless steel 不锈钢
----------	------------------------



Mod:D028	Stainless steel+ Silicone 不锈钢+硅胶
----------	-------------------------------------



Mod:D029	Stainless steel+ Silicone 不锈钢+硅胶
----------	-------------------------------------



Mod:D030	Stainless steel 不锈钢
----------	------------------------





Mod:D033

Stainless steel
不锈钢



Mod:D034

Stainless steel
不锈钢



Mod:D042

Stainless steel
不锈钢



Mod:D043

Stainless steel
不锈钢

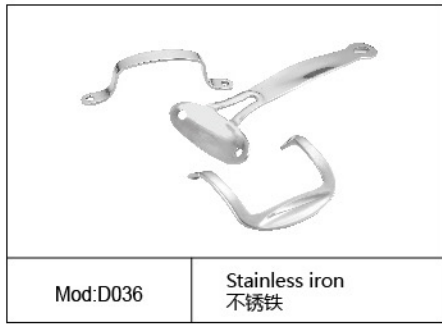

Mod:D036

Stainless iron
不锈钢

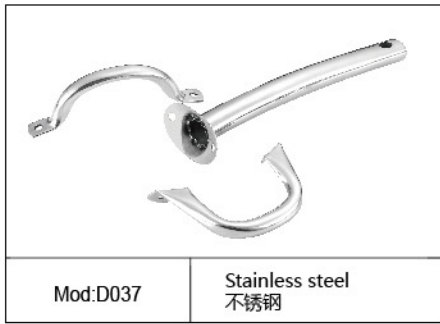

Mod:D037

Stainless steel
不锈钢

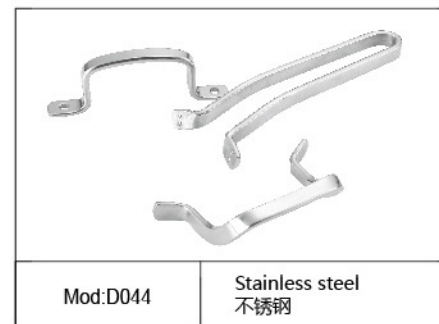

Mod:D044

Stainless steel
不锈钢

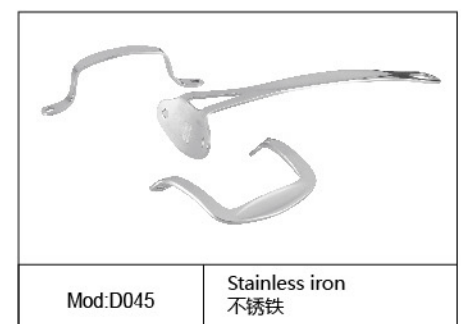

Mod:D045

Stainless iron
不锈钢



Mod:D038

Stainless steel+ Silicone
不锈钢+硅胶



Mod:D039

Stainless iron+ Silicone
不锈钢+硅胶

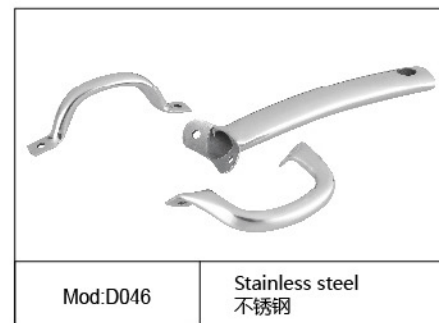

Mod:D046

Stainless steel
不锈钢



Mod:D047

Stainless steel
不锈钢



Mod:D040

Stainless steel
不锈钢

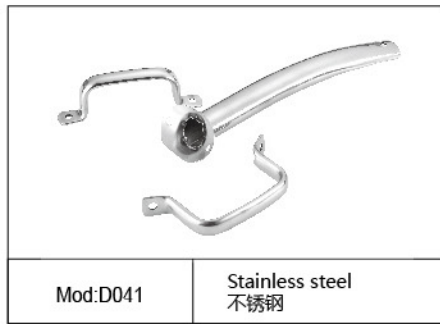

Mod:D041

Stainless steel
不锈钢

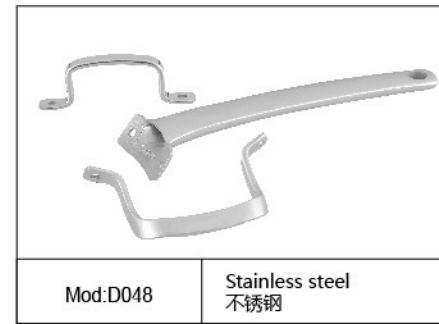

Mod:D048

Stainless steel
不锈钢



Mod:D049

Stainless steel
不锈钢

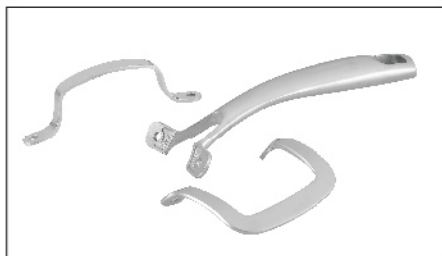

Mod:D050

Stainless steel
不锈钢

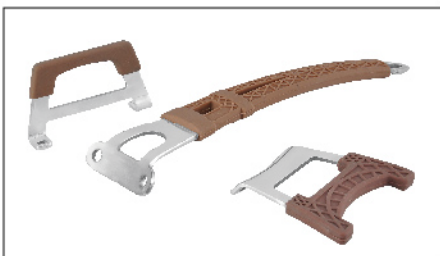

Mod:D051

Stainless steel+ Silicone
不锈钢+硅胶



Mod:D058

Bakelite
胶木



Mod:D059

Bakelite+Stainless steel
胶木+不锈钢



Mod:D052

Stainless steel
不锈钢



Mod:D053

Stainless steel+ Silicone
不锈钢+硅胶



Mod:D060

Bakelite+Stainless steel
胶木+不锈钢



Mod:D061

Bakelite+Stainless steel
胶木+不锈钢



Mod:D054

Stainless steel
不锈钢



Mod:D055

Stainless steel
不锈钢



Mod:D062

Bakelite
胶木



Mod:D063

Stainless steel
不锈钢



Mod:D056

Stainless steel
不锈钢



Mod:D057

Stainless steel
不锈钢



Mod:D064

Stainless steel
不锈钢



Mod:D065

Stainless iron
不锈钢



Mod:E001 Stainless steel
不锈钢



Mod:E002 Aluminium
铝



Mod:E003 Aluminium
铝



Mod:E004 Aluminium
铝



Mod:E005 Aluminium
铝



Mod:E006 Aluminium
铝

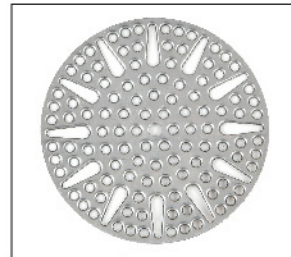

Mod:F007 Sun flower
太阳花



Mod:F008 Sun flower
太阳花



Mod:F009

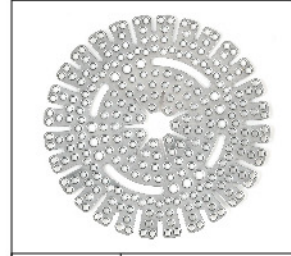

Mod:F010 Sun flower
太阳花

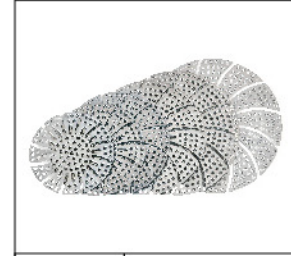

Mod:F011

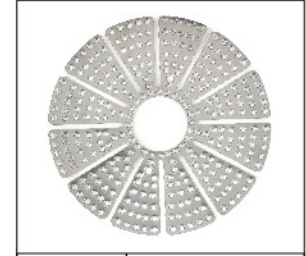

Mod:F013 Sun flower
太阳花



Mod:F001 Baby breath
满天星



Mod:F002 Strip
条形



Mod:F003 Sun flower
太阳花

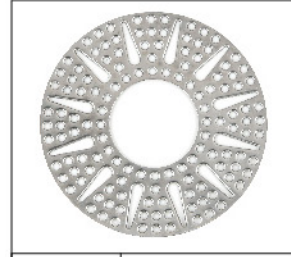

Mod:F014 Sun flower
太阳花

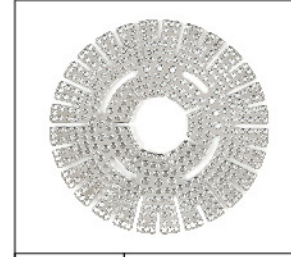

Mod:F015 Sun flower
太阳花

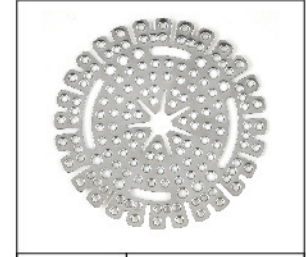

Mod:F016 Sun flower
太阳花



Mod:F004 Cone
锥形



Mod:F005 Sun flower
太阳花



Mod:F006 Sun flower
太阳花



Mod:G001 Stainless steel
不锈钢



Mod:G002 Aluminium
铝



Mod:G003 Aluminium
铝

